

CLT - spring driven cable reels



Manufactured by **Cavotec Alfo**



General Information

Spring driven cable reels are subject to the standards and norms as specified in the latest edition of VDE 0100 and the UVV.

The springs are made of special high-grade steel which guarantees a long lifetime. Every spring is mounted inside a spring housing in order to avoid friction and wear.

The slipping assembly is mounted in a solid glassfiber reinforced plastic housing that can withstand corrosion and mechanical wear. The housing is designed to minimise condensation and to guarantee complete water tightness through glands and seals.

Corrosion protection is also an important feature of Cavotec Alfo reels. All steel plates and parts are either hot dip galvanised or have a polyester coating. Cavotec Alfo offers, as an option, all external parts such as screws, nuts and bolts in stainless steel.

Our warranty follows the general delivery conditions of the electric industry for products and services. Wear parts are exempted from the warranty. See also our Terms of Delivery.

Instructions regarding installation

The drum should be installed in such a way to ensure that the cable is reeled and unreeled to and from the drum without interference. Forced guidance and too small bending radius on sheaves and roller guides should be avoided at all times. The innovative design of the Cavotec Alfo spring reels allows the feeding point of the cable to be placed on either side of the drum. To relieve tension ensure that 1 or 2 additional reeling turns ($d \cdot \pi \cdot 2$) remain on the drum when the maximum traveling distance has been reached.

For examples please refer to page 6.

Cable selection

Our cable range includes a wide variety of flexible cables for reeling applications which can withstand the highest

mechanical stresses and harsh ambient conditions.

When selecting the cable, please take into consideration the cable data and the instructions provided by the manufacturer. In order to make the correct reel selection it is absolutely necessary to know the correct operating conditions. It is important to take into consideration the heating of the cable due to the number of layers on the drum and not to exceed the maximum allowed tension of the cable.

The data contained in the selection tables on page 7 are related to flexible cables of short lengths. The ambient temperature is assumed to be within +30°C to -10°C. Lower temperatures may require a higher spring force due to the higher rigidity of the cable.

The drum selection tables have been calculated with the maximum values (of each bracket) of diameter and weight. Consequently there could be significant deviations in specific cases.

Reeling cable on drum

It is an absolute necessity to reel the cable onto the drum without twists or bends. To this end, lay out the complete cable straight along the travel length. When reeling the cable on the drum be sure to maintain the same reeling direction used on the wooden drum delivered by the manufacturer.

Selecting the cable cross-section

When selecting the cable cross-section it is important to take in consideration the maximum current allowed (thermal heating) and the voltage drop limits, as well as the maximum tension allowed. The most important factors are:

1. Max. current load allowed according to norms and manufacturer's data.
2. Reduction factors due to duty cycle
3. Ambient temperature
4. Number of cable layers on the drum

Important: The number of layers $L_z = 4$ should not be exceeded as $L_z > 4$ gives higher current reduction and worse reeling conditions. You will find the upper limits in the selection tables.

5. Reduction factor when using multi-core cables. Relevant values are given by the cable manufacturer.

Using roller guides and sheaves

When roller guides and sheaves are used, it is important to avoid reverse bending whenever possible. The following example illustrates the correct usage of roller guides.

Unreeling direction

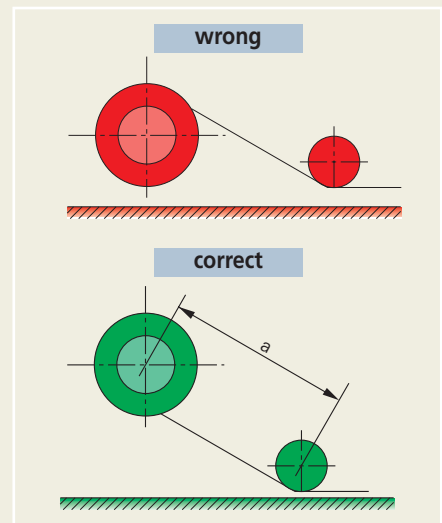

Standard unreeling direction is anticlockwise, when looking into the slipping body, i.e. to the left when unreeling the cable.

Code key

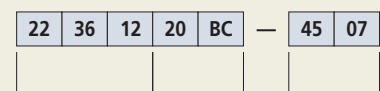

22 - 36 Drum size
22: 220mm inner Ø
36: 360mm outer Ø
12: 125mm drum width

45 - 07 Slipping assembly
45: Slipping type
07: number of poles incl. PE (earth)

20 BC Spring type
20: number and configuration of springs
BC: type of spring

Operating voltages

Please find the operating voltages in the respective slipping data tables.

Maximum current values

All drums and slipping bodies are designed for the maximum allowed current values of the cable at 100% ED. (duty cycle). Please find the maximum allowed values in the respective slipping data tables.

Earth conductor and number of poles

All drums and slipping bodies for voltages > 24V are manufactured with an un-insulated protective earth conductor (PE). Number of poles = number of insulated poles including PE. In your order form, please state the number of poles, protective earth conductor, and operating voltage.

Extreme operating conditions

Extreme environmental and operating conditions must be given additional attention. The following factors are of primary importance:

- extreme high and low temperatures
- significant temperature variations
- high air humidity
- strong vibrations
- heavily polluted and aggressive air
- use in a marine environment

The force of the springs in spring reeling drums, may have to be increased if:

- the unit is moving at very low speed ($v < 10$ m/min)
- significant deflections of the cable is necessary
- at high acceleration and speeds
- the temperature is lower than -10°C .

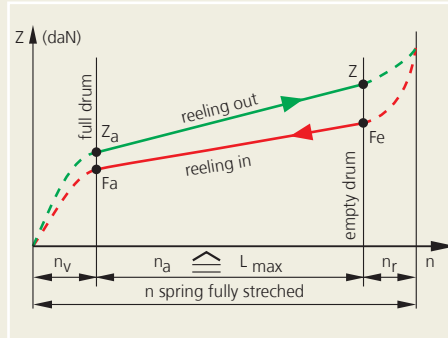

L_{max} = max. operating reeling length (m)
 n_a = operational reeling turns
 n_v = spring preload turns
 n_r = extra spare turns
 F_a = Remaining spring load at full drum
 F_e = Remaining spring load at empty drum
 Z = necessary pulling force at vertical application (cable fully unreeled)
Please note: Spring forces refers to the corresponding inner drum \emptyset

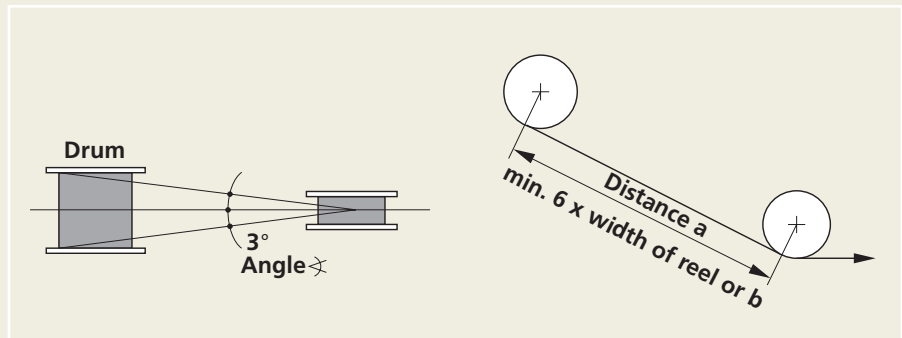

When spring reels are mounted low, the cable must always leave the drum from the top. If roller guides or sheaves are used it is important to respect a minimum distance (a) between drum and guide.



Cavotec Alfa spring driven reels are a common sight in theatre applications around the world.

General Information

APPLICATION EXAMPLES

Case 1 & 2

Horizontal mobile application

The cable is unreeled on a flat and continuous surface. The cable is unreeled horizontally in either travelling directions.

Case 3 & 4

Horizontal mobile application

The cable is reeled out on supports ($L1 < 1\text{m}$) or on rollers or rounded smooth supports ($L1 = 1$ to 3m , depending on the cable size). The cable is unreeled horizontally in either travelling directions.

Case 5

Stationary application

The cable is unreeled horizontally in either travelling directions through support rollers ($L1 = 1$ to 3m , depending on the cable size). *This type of application is not recommended.*

Case 6 & 7

Horizontal mobile application

The cable is unreeled horizontally, above the ground and without support, in either travelling directions. The catenary $f1$ must be calculated accurately. As a rule the value of f_{max} is approximately 10% of L .

Case 8 & 9

Vertical application

The cable is unreeled vertically downwards (downward inclination). Alternatively the cable is unreeled vertically upwards (upward inclination).

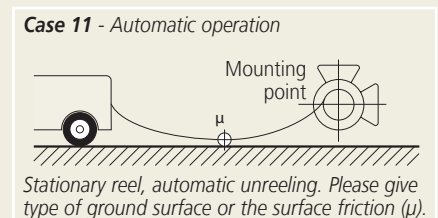
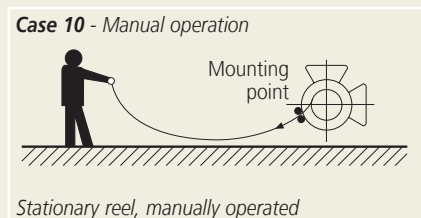
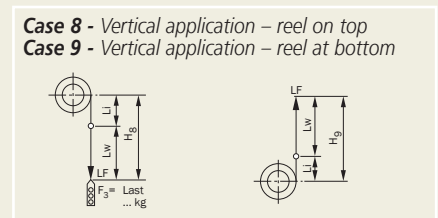
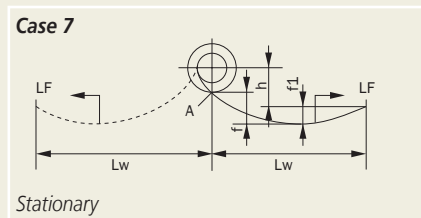
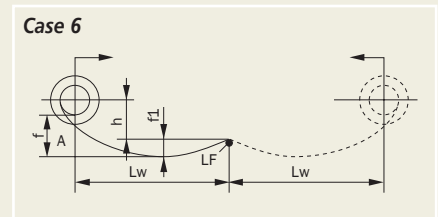
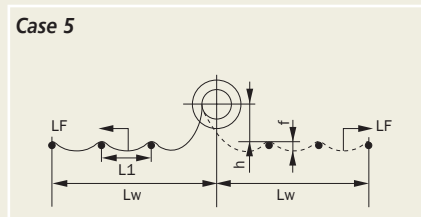
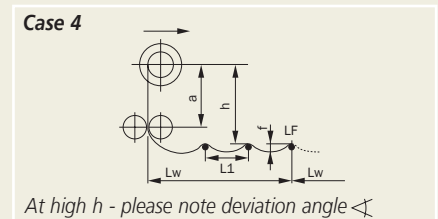
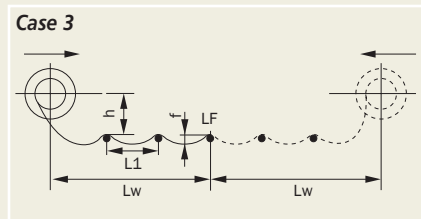
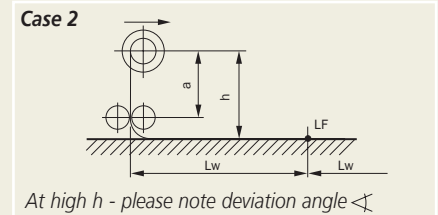
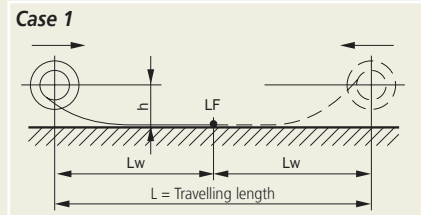

Explanation of the symbols (case 1 to 7): Lw = maximum reeling cable length [m], (reeling length for reels travelling in both directions = one-half of the total travelling length); h = (installation height) distance between cable deposit plane and drum centre [m]; LF = cable feeding point; f = maximum cable sag [m], in case 6 and 7 related to position A in drawing; $f1$ = maximum cable sag [m], related to cable feeding point LF; $L1$ = roller or support distance [m]

$$\text{Calculation formula } f/f1 \text{ (m)} \sim \frac{10 \times L^2 \times g}{8 \times F}$$

L = support distance [m]; g = cable weight [kg/m]; F = pulling force [Newton]

Explanation of the symbols (case 8 and 9): Lw = maximum reeling cable length [m]; $H8/9$ = maximum cable length hanging down from the drum [m]. The drum is selected according to the total cable weight of the hanging cable. Additional weight ($F3$) must be considered and added to the cable weight.

From:
Date: Inquiry No
Person in charge:

To:

Questionnaire for spring-driven cable

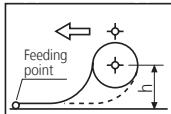

Quantity: Delivered with cable without cable

1 Mobile application

Cable
Cable type: _____ Cross section: x mm², Outside dia ø mm, Weight kg/m

Total length of the cable $L_{1,\Sigma} =$ m
($L_{1,\Sigma} =$ reeling length + 2 dead turns as tension relief + connections and/or installed cable outside of the cable reel)

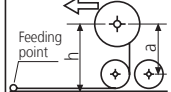

2 Mobile application

Slipping collector
Number of isolated poles + earth conductor yes no
Current min. mA max A Voltage min/max. / V,

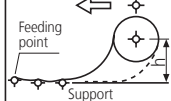

3 Mobile application

Mountin
Horizontal track length $L =$ m, of which travel distance $L_w =$ m
Installation height $h =$ m, roller guide yes no Distance $a =$ m
In case that "h" is < 0,6m the cable should always run off the cable reel from the top.

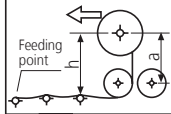

4 Mobile application

Applications type
Horizont
electrical end supply electrical supply at centre of which travel distance $L_{w1} =$ m $L_{w2} =$ m
Vertical
vertical hoist height $H =$ m hoist distance $L_w =$ m additional load $F =$ kg
travel hoist speed $v =$ m/min acceleration $b =$ m/s²

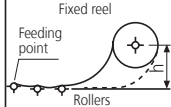

5 Stationary application

Special requirement
Automatic operation manual operation return locking only manual operation application outdoors indoors
temp. - / + °C wide drum monospiral reel hot-dip galvanised + polyester coating
marine environment high number of operations operations/per year strong vibration dusty air
humidity % other: _____

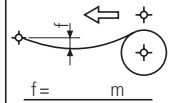

6 7

Direction of unreeling (seen from slipping)
standard anticlockwise clockwise
sketch (please fill in, important): max. installation dimensions: Ø = mm total width: mm

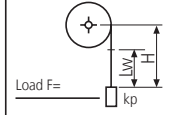

8 Vertical downwards

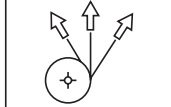

9 Vertical upwards

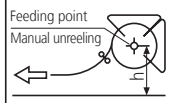

10 Stationary application

[Grid area for sketching installation dimensions]	
---	--

Note

General information

CABLE CALCULATION TABLES

Selecting the correct cable for your application is extremely important. This page shows the Cavotec Alfo range of cables and their relative technical specifications. For specific help in selecting the correct cable or, if you have any special requirement for your type of application, please contact your local Cavotec office.

Special reeling cables - NSHT

Cross sec.	kg/km	Ø (mm)	Max. allowed tension
			N
4 x 1,5	157	10,2	150
5 x 1,5	176	10,8	190
7 x 1,5	245	12,9	265
12 x 1,5	337	16,8	450
18 x 1,5	526	18,6	675
24 x 1,5	662	21,3	900
30 x 1,5	901	24,6	1125
36 x 1,5	953	29,0	1350
42 x 1,5	1192	29,5	1575
4 x 2,5	208	11,7	250
5 x 2,5	263	12,7	315
7 x 2,5	327	14,8	440
12 x 2,5	533	18,4	750
18 x 2,5	725	21,1	1125
24 x 2,5	988	24,8	1500
30 x 2,5	1300	28,8	1875
36 x 2,5	1411	32,4	2250
4 x 4	270	12,5	600
5 x 4	362	14,3	900
4 x 6	409	16,9	900
5 x 6	511	17,8	750
7 x 6	715	20,9	1050
4 x 10	633	19,6	1000
5 x 10	766	20,9	1250
4 x 16	936	23,8	1600
5 x 16	1173	25,5	2000
4 x 25	1483	27,7	2500

Calculation table for multi-layer reels/drums (VDE 0298 part 4 1995 table 19)

No. of layers	1	2	3	4	5
Correction factor	0,76	0,58	0,47	0,4	0,38

Note: for spiraled cables the correction factor is 0,76.

Current capacity correction factor for multi-core cables*°

No. loaded conductors	5	7	10	14	19	24	40	61
Correction factor	0,75	0,65	0,55	0,50	0,45	0,40	0,35	0,30

* VDE 0298 part 4 1995 table 18

° max. conductor size 10 mm²

Ambient temperature for NSHT cable

Temperature °C	25-30	30-35	35-40	40-45	45-50	50-55	55-60	60-65	65-70	70-75
Correction factor	1	0,95	0,98	0,84	0,77	0,71	0,63	0,55	0,45	0,32

CLT MODULAR SYSTEM

The concept of the Cavotec Alfo CLT reels is to provide a modular system that retains all the quality and reliability of a standard spring driven cable reel. To guarantee the above, all assembly will take place at Cavotec Alfo by our specially trained and experienced staff. Only when requested will we ship the separate components of the CLT reels unassembled. In this case the modular design allows for easy storage and thanks to the innovative design of the reels, replacing just one part is extremely easy.

The photographs on right show the different packages that can be ordered from Cavotec Alfo. Please refer to the code-tables on the following pages to ascertain the correct codes for your specific CLT reel.

Side plates



Mounting flange



Slipping collector



Spring body



Mounted drum



Drum mounted with cable



Spring driven cable reel CLT 15

CHOICE OF CABLE REEL ACCORDING TO SEARCH KEY 1.1 TO 1.4

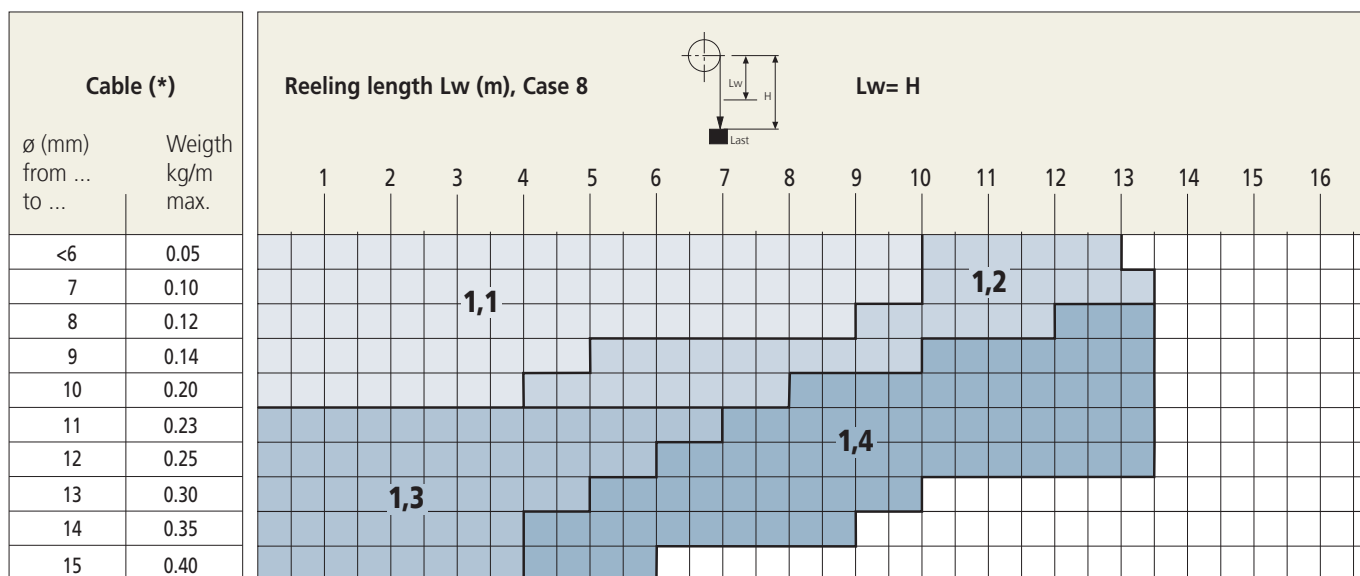
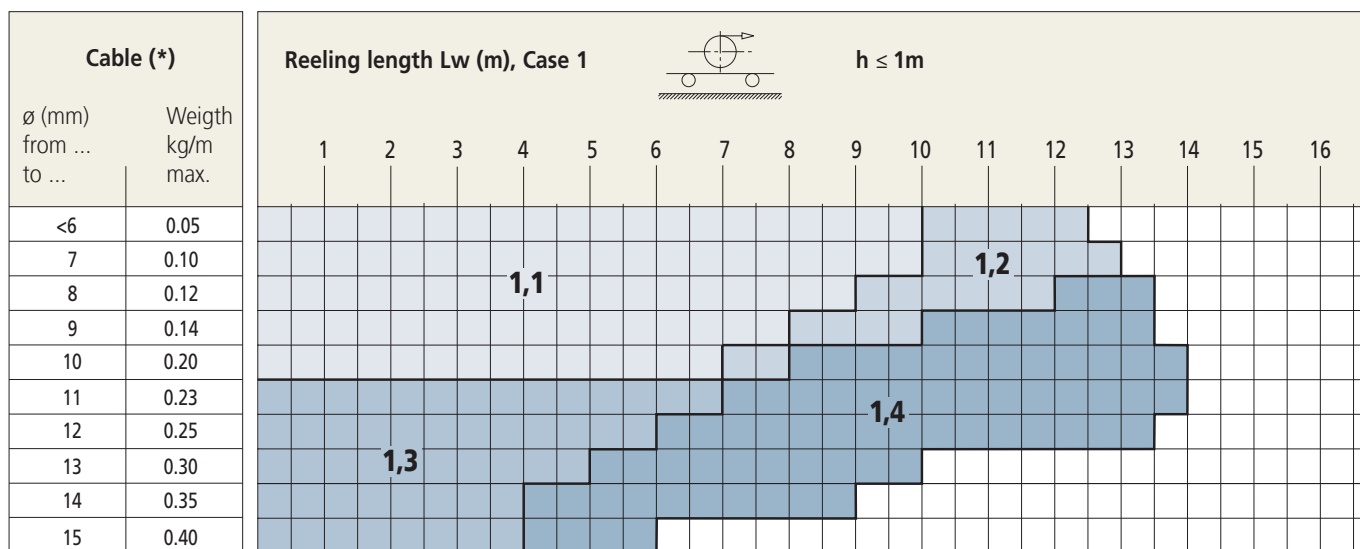

Search key	Drum type
1.1	15240910AC
1.2	15290910AC
1.3	15240912AC
1.4	15290912AC

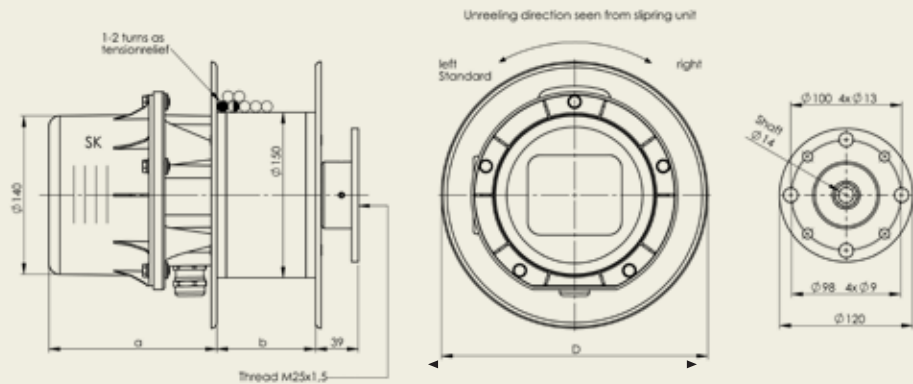

Spring-body	b	na	nv	nr	Z (daN)	Fe (daN)	Item-Nr.
Spring-body 15..0910AC	89mm	22	4	1	2,0	3,4	A01-C10AC09F0
Spring-body 15..0912AC	89mm	22	4	1	4,0	6,8	A01-C12AC09F0

Other spring configurations upon request

Side plate (2 pcs.)	D	Item-Nr.
Side plate CLT 15-24	240mm	A04-C15-24-0B
Side plate CLT 15-29	290mm	A04-C15-29-0B

Slipping-body	No. rings	Max. cable types	Current	Max. Voltage	a	Cable gland	Item-Nr.
GSK CLT 45-04	3 x 25A + PE	4 x 2,5	50mA - 25A	415V	130mm	M20	A02-C450414-0
GSK CLT 45-05	4 x 25A + PE	5 x 2,5	50mA - 25A	415V	150mm	M25	A02-C450514-0
GSK CLT 45-07	6 x 25A + PE	7 x 2,5	50mA - 25A	415V	190mm	M25	A02-C450714-0
GSK CLT 45-12	11 x 25A + PE	12 x 1,5	50mA - 25A	415V	190mm	M32	A02-C451214-0
GSK CLT 46-04	3 x 25A + PE	4 x 4	50mA - 25A	415V	130mm	M25	A02-C460414-0
GSK CLT 46-05	4 x 25A + PE	5 x 4	50mA - 25A	415V	150mm	M25	A02-C460514-0

Deviating other types upon request

Accessories	Item-Nr.
Rigid mounting base	AA9-L25680-0Z
Guidearm short b=90	A06-A1530090Z

Spring driven cable reel CLT 22

CHOICE OF CABLE REEL ACCORDING TO SEARCH KEY 1.1 TO 4.6

Cable (*)		Reeling length L_w (m), Case 1	
\varnothing (mm) from ... to ...	Weight kg/m max.	$h \leq 1m$	
<8	0.09	1-4	5-29
8 - 10	0.15	5-9	10-29
10 - 12	0.25	10-14	15-29
12 - 14	0.30	11-18	20-29
14 - 16	0.40	12-23	25-29
16 - 18	0.45	13-24	26-29
18 - 20	0.55	14-24	27-29
20 - 22	0.70	15-24	28-29

Cable (*)		Reeling length L_w (m), Case 8	
\varnothing (mm) from ... to ...	Weight kg/m max.	$L_w = H$	
<8	0.09	1-4	5-29
8 - 10	0.15	5-9	10-29
10 - 12	0.25	10-14	15-29
12 - 14	0.30	11-18	20-29
14 - 16	0.40	12-23	25-29
16 - 18	0.45	13-24	26-29
18 - 20	0.55	14-24	27-29
20 - 22	0.70	15-24	28-29

Gray background: Diameter of axis hole is 15mm



The photograph shows a CLT 22 reel mounted with a SK 58 slipping collector.

Search key	Drum type
2.2	22361220BC -
2.3	22431220DC -
3.4	22431630DC -
2.6	22431220DC -
3.5	22431630EB -
3.6	22431630DC -
4.6	22431220EB -

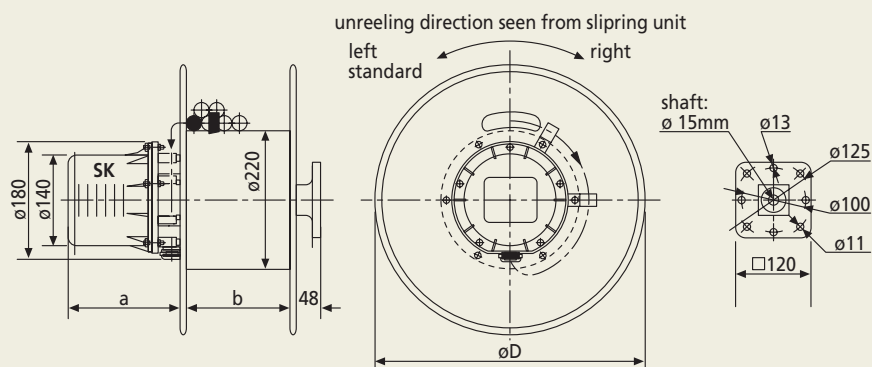

Spring-body	b	Turns (work)	n_v	n_r	Z (daN)	Fe (daN)	Item-Nr.
Spring-body 22..1212DC	125mm	13	2	1,5	21,6	20,6	A01-C12DC12-0
Spring-body 22..1220EB	125mm	18	5	2	15,0	14,5	A01-C20EB12-0
Spring-body 22..1220DC	125mm	26	4	3	10,8	10,3	A01-C20DC12-0
Spring-body 22..1220BC	125mm	32	8	3	6,1	6,1	A01-C20BC12-0
Spring-body 22..1630EB	165mm	27	7,5	3	15,0	14,5	A01-C30EB16-0
Spring-body 22..1630DC	165mm	39	6	4,5	10,8	10,3	A01-C30DC16-0

Other spring configurations upon request

Side plate (2 pcs.)	D	Item-Nr.
Side plate CLT 22-36	360mm	A04-C22-36-0Z
Side plate CLT 22-43	430mm	A04-C22-43-0Z

Slipring-body	No. rings	Max. cable types	Current	Max. Voltage	a	ø Housing	Item-Nr.
GSK CLT 45-04	3 x 25A + PE	4 x 2,5	50mA - 25A	415V	130mm	140mm	A02-C450414-0
GSK CLT 45-05	4 x 25A + PE	5 x 2,5	50mA - 25A	415V	150mm	140mm	A02-C450514-0
GSK CLT 45-07	6 x 25A + PE	7 x 2,5	50mA - 25A	415V	190mm	140mm	A02-C450714-0
GSK CLT 45-12	11 x 25A + PE	12 x 2,5	50mA - 25A	415V	245mm	140mm	A02-C451214-0
GSK CLT 45-18	17 x 25A + PE	18 x 2,5	50mA - 25A	415V	325mm	140mm	A02-C451814-0
GSK CLT 46-04	3 x 25A + PE	4 x 4	50mA - 25A	415V	130mm	140mm	A02-C460414-0
GSK CLT 46-05	4 x 25A + PE	5 x 4	50mA - 25A	415V	150mm	140mm	A02-C460514-0
GSK CLT 47-04	3 x 50A + PE	4 x 6	50mA - 50A	500V	150mm	140mm	A02-C470414-0
GSK CLT 47-05	4 x 50A + PE	5 x 6	50mA - 50A	500V	160mm	140mm	A02-C470514-0

Deviating other types upon request

Mounting flange	Item-Nr.
Mounting flange	AA4-A00411-0A
Mounting flange with roll back lock	A09-D0220C-0Z

Accessories	Item-Nr.
Rigid mounting base	AA9-L05361-0Z
Guidarm short b=125	A06-A2255120Z
Guidarm short b=165	A06-A2255160Z

Standard option coated steel parts
VA screws

Spring driven cable reel CLT 28

CHOICE OF CABLE REEL ACCORDING TO SEARCH KEY 1.1 TO 7.4

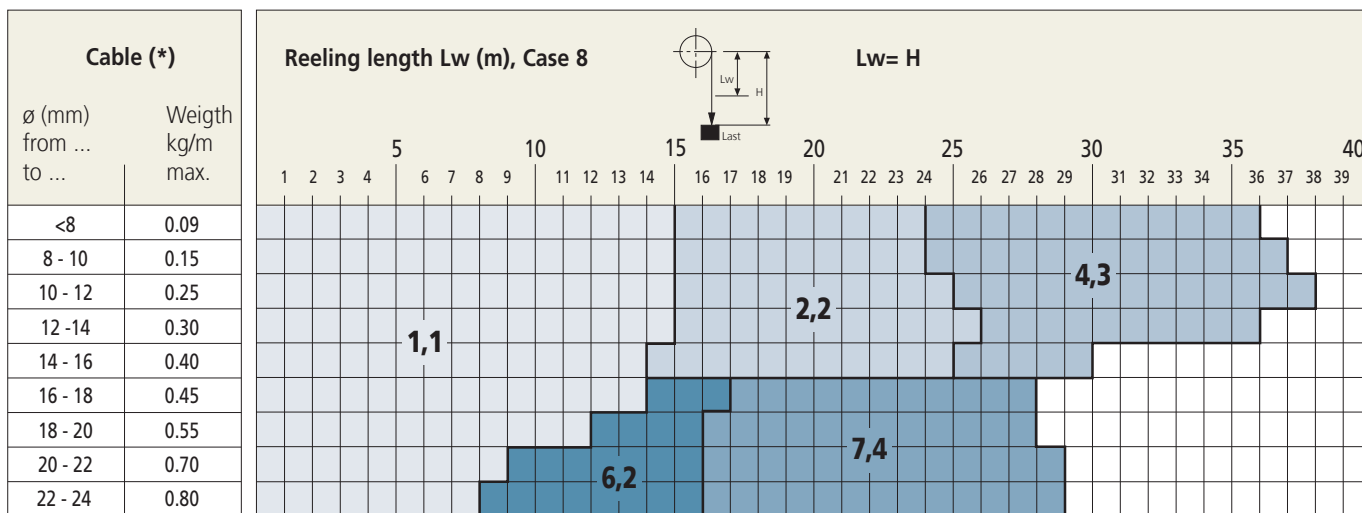
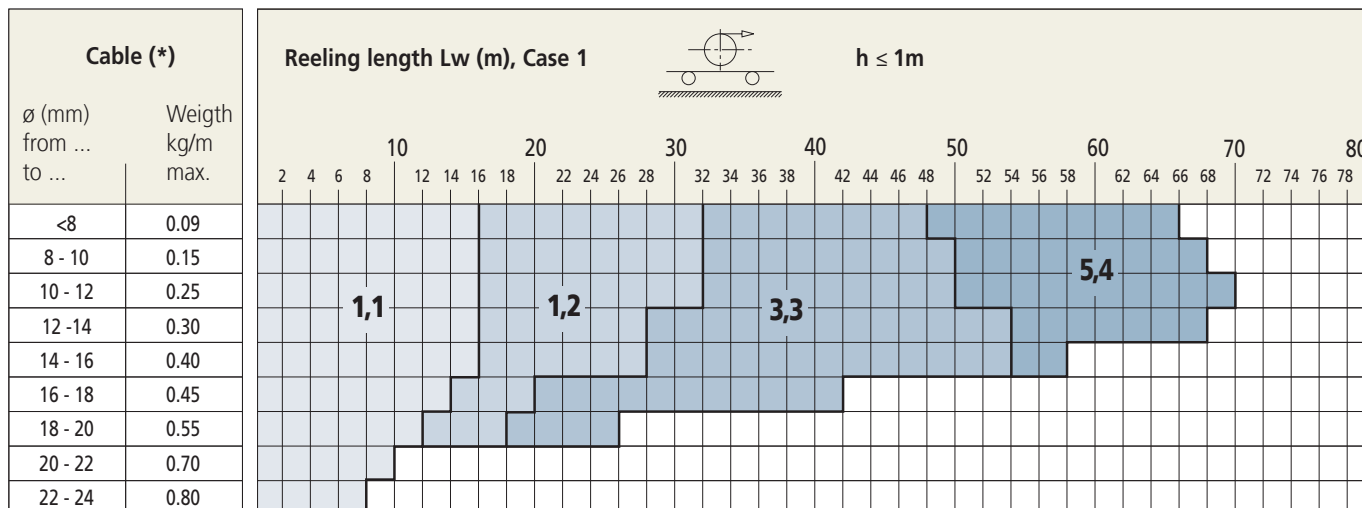

A SK 47 type slipping collector mounted inside its housing.

Search key	Drum type
1.1	28431610EA -
1.2	28431620EA -
2.2	28501620HA -
3.3	28432030EA -
4.3	28502030HA -
5.4	28502040EA -
6.2	28501612EA -
7.4	28502022HA -

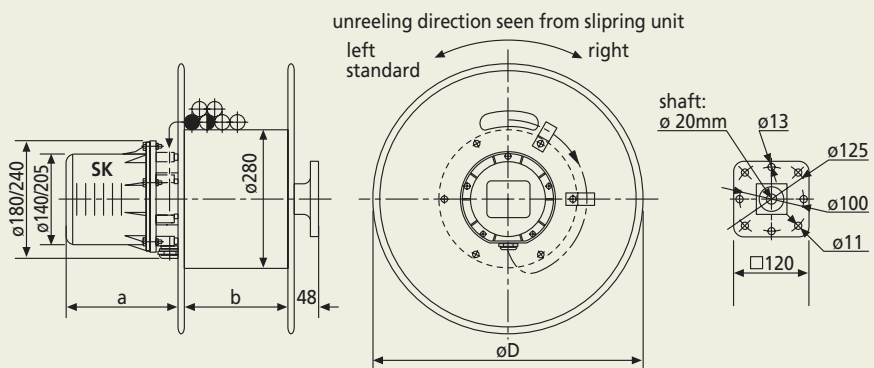

Spring-body	b	Turns (work)	n_v	n_r	Z (daN)	Fe (daN)	Item-Nr.
Spring-body 28..1610EA	165mm	17	3	1,5	12,0	10,0	A01-C10EA16-0
Spring-body 28..1620EA	165mm	34	6	3	12,0	10,0	A01-C20EA16-0
Spring-body 28..1620HA	165mm	26	6	3	19,0	17,5	A01-C20HA16-0
Spring-body 28..2030EA	205mm	51	9	4,5	12,0	10,0	A01-C30EA20-0
Spring-body 28..2030HA	205mm	39	9	4,5	19,0	17,5	A01-C30HA20-0
Spring-body 28..2040EA	205mm	68	12	6	12,0	10,0	A01-C40EA20-0
Spring-body 28..1612EA	165mm	17	3	1,5	24,0	20,0	A01-C12EA16-0
Spring-body 28..2022EA	205mm	26	6	3	38,0	35,0	A01-C22HA20-0

Other spring configurations upon request

Side plate (2 pcs.)	D	Item-Nr.
Side plate CLT 28-43	430mm	A04-C28-43-0Z
Side plate CLT 28-46	460mm	A04-C28-46-0Z
Side plate CLT 28-50	500mm	A04-C28-50-0Z
Side plate CLT 28-55	550mm	A04-C28-55-0Z

Slipring-body	No. rings	Max. cable types	Current	Max. Voltage	a	ø Housing	z	Item-Nr.
GSK CLT 45-04	3 x 25A + PE	4 x 2,5	50mA - 25A	415V	130mm	140mm		A02-C450414-0
GSK CLT 45-05	4 x 25A + PE	5 x 2,5	50mA - 25A	415V	150mm	140mm		A02-C450514-0
GSK CLT 45-07	6 x 25A + PE	7 x 2,5	50mA - 25A	415V	190mm	140mm		A02-C450714-0
GSK CLT 45-12	11 x 25A + PE	12 x 2,5	50mA - 25A	415V	245mm	140mm		A02-C451214-0
GSK CLT 45-18	17 x 25A + PE	18 x 2,5	50mA - 25A	415V	325mm	140mm		A02-C451814-0
GSK CLT 46-04	3 x 25A + PE	4 x 4	50mA - 25A	415V	130mm	140mm		A02-C460414-0
GSK CLT 46-05	4 x 25A + PE	5 x 4	50mA - 25A	415V	150mm	140mm		A02-C460514-0
GSK CLT 47-04	3 x 50A + PE	4 x 6	50mA - 50A	500V	150mm	140mm		A02-C470414-0
GSK CLT 47-05	4 x 50A + PE	5 x 6	50mA - 50A	500V	160mm	140mm		A02-C470514-0
GSK CLT 02-04	3 x 50A + PE	4 x 10	50mA - 50A	500V	205mm	205mm		A02-C020420-0
GSK CLT 02-05	4 x 50A + PE	5 x 10	50mA - 50A	500V	205mm	205mm		A02-C020520-0
GSK CLT 03-04	3 x 90A + PE	4 x 16	50mA - 90A	500V	205mm	205mm		A02-C030420-0
GSK CLT 03-05	4 x 90A + PE	5 x 16	50mA - 50A	500V	205mm	205mm		A02-C030520-0
GSK CLT 98-18	17 x 25A + PE	18 x 2,5	30mA - 25A	500V	205mm	205mm		A02-C981820-0
GSK CLT 98-24	23 x 25A + PE	24 x 2,5	30mA - 25A	500V	205mm	205mm		A02-C982420-0

Deviating other types upon request

Mounting flange	Item-Nr.
Mounting flange	AA4-A00412-0A
Mounting flange with roll back lock	A09-D0280C-0Z

Accessories	Item-Nr.
Rigid mounting base	AA9-L05361-0Z
Guidearm short b= 165	A06-A2255160Z
Guidearm short b= 205	A06-A2255200Z

Spring driven cable reel CLT 40

CHOICE OF CABLE REEL ACCORDING TO SEARCH KEY 1.1 TO 5.21

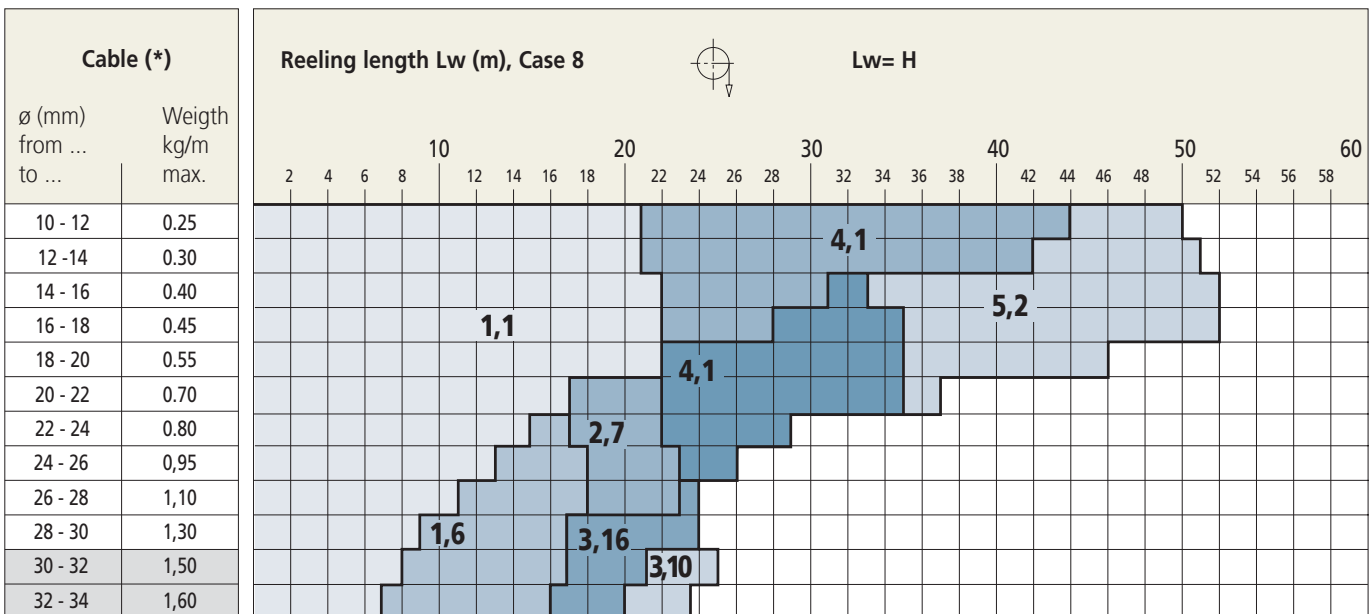
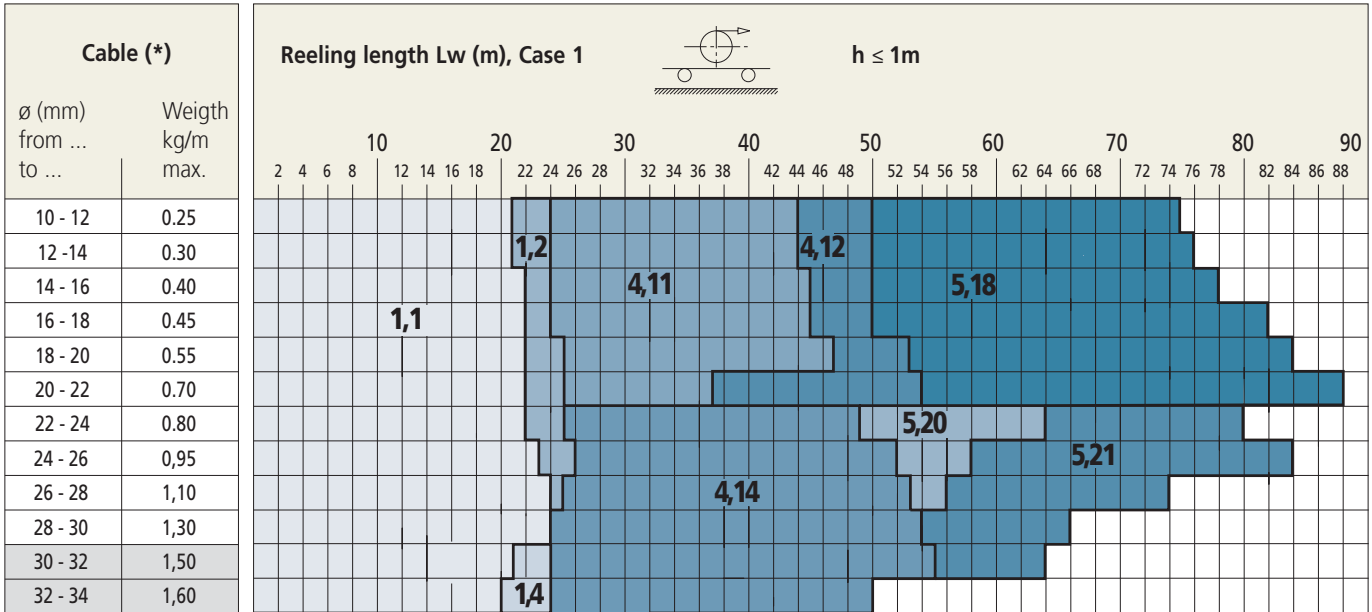

Gray background: Diameter of axis hole is 30mm

Search key	Drum type
1.1	40562810TA –
1.2	40562810SA –
1.4	40712810TA –
1.6	40632810UA –
2.7	40562812TA –
3.10	40712813TA –
4.11	40562820TA –
4.12	40632820SA –
4.14	40802820TA –
4.15	40562820UA –
5.18	40712830SA –
5.21	40802830TA –
5.22	40632830UA –

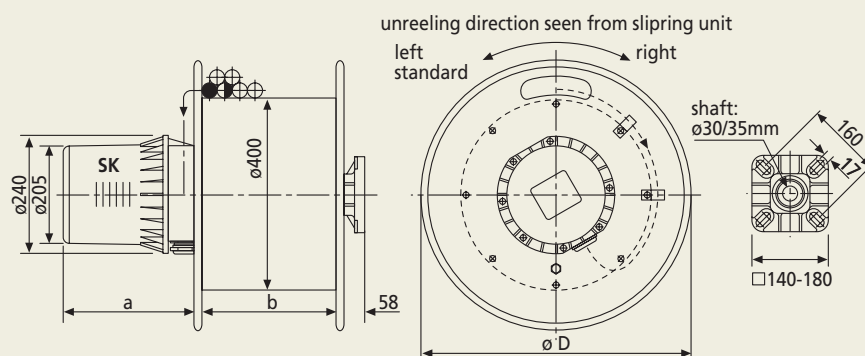

Spring-body	b	Mod. shaft (ø)	Turns (work)	n _v	n _r	Z (daN)	Fe (daN)	Item-Nr.
Spring-body 40..2810TA	280mm	35	17	2,5	1,5	24	20	A01-C10TA28-0
Spring-body 40..2810SA	280mm	35	20	3,5	1,5	15	13	A01-C10SA28-0
Spring-body 40..2810UA	280mm	35	13	2,5	1,0	46	39	A01-C10UA28-0
Spring-body 40..2812TA	280mm	35	17	2,5	1,5	48	40	A01-C12TA28-0
Spring-body 40..2813TA	280mm	35	17	2,5	1,5	72	60	A01-C20TA28-0
Spring-body 40..2820TA	280mm	30	34	5	3	24	20	A01-C10UA28-0
Spring-body 40..2820SA	280mm	30	40	7	3	15	13	A01-C20SA28-0
Spring-body 40..2820UA	280mm	30	26	5	2	46	39	A01-C20UA28-0
Spring-body 40..2830TA	280mm	30	51	7,5	4,5	24	20	A01-C30TA28-0
Spring-body 40..2830SA	280mm	30	60	10,5	4,5	15	13	A01-C30SA28-0
Spring-body 40..2830UA	280mm	30	39	7,5	3	45	39	A01-C230UA28-0

Other spring configurations upon request

Side plate (2 pcs.)	D	Item-Nr.
Side plate CLT 40-56	560mm	A04-C40-56-0Z
Side plate CLT 40-63	630mm	A04-C40-63-0Z
Side plate CLT 40-71	710mm	A04-C40-71-0Z
Side plate CLT 40-80	800mm	A04-C40-80-0Z

Slipring-body	No. rings	Max. cable types	Current	Max. Voltage	a	ø Housing	z	Item-Nr.
GSK CLT 45-04	3 x 25A + PE	4 x 2,5	50mA - 25A	415	205mm	205mm		A02-C450421-0
GSK CLT 45-05	4 x 25A + PE	5 x 2,5	50mA - 25A	415	205mm	205mm		A02-C450521-0
GSK CLT 45-07	6 x 25A + PE	7 x 2,5	50mA - 25A	415	205mm	205mm		A02-C450721-0
GSK CLT 45-12	11 x 25A + PE	12 x 2,5	50mA - 25A	415	295mm	205mm		A02-C451221-0
GSK CLT 45-18	17 x 25A + PE	18 x 2,5	50mA - 25A	415	390mm	205mm		A02-C451821-0
GSK CLT 02-04	3 x 50A + PE	4 x 10	50mA - 50A	500	205mm	205mm		A02-C020421-0
GSK CLT 02-05	4 x 50A + PE	5 x 10	50mA - 50A	500	205mm	205mm		A02-C020521-0
GSK CLT 03-04	3 x 90A + PE	4 x 16	50mA - 90A	500	205mm	205mm		A02-C030421-0
GSK CLT 03-05	4 x 90A + PE	5 x 16	50mA - 90A	500	205mm	205mm		A02-C030521-0
GSK CLT 98-18	17 x 25A + PE	18 x 2,5	30mA - 24A	500	295mm	205mm		A02-C901821-0
GSK CLT 98-24	23 x 25A + PE	24 x 2,5	30mA - 25A	500	295mm	205mm		A02-C902421-0

Deviating other types upon request

Mounting flange	Item-Nr.
Mounting flange	AA4-A12060-0A
Mounting flange with roll back lock	A09-D04050-0Z

Accessories	Item-Nr.
Rigid mounting base	AA9-L04651-0Z
Guidearm short b= 280	A06-A4080280Z

Представитель Cavotec в России и СНГ

ООО «ТАУБЕР»

Россия, 125438, г. Москва,

ул. Михалковская, д. 63 Б, стр. 4

тел.: +7(495)617-00-04

e-mail: info@cavotec.com.ru

web: www.cavotec.com.ru

We are present in

Argentina	Norway
Australia	Russia
Bahrain	Singapore
Belgium	South Africa
Brazil	South Korea
Canada	Spain
China	Sweden
Denmark	Switzerland
Finland	UAE
France	UK
Germany	USA
Hong Kong	
India	
Italy	
The Netherlands	
New Zealand	

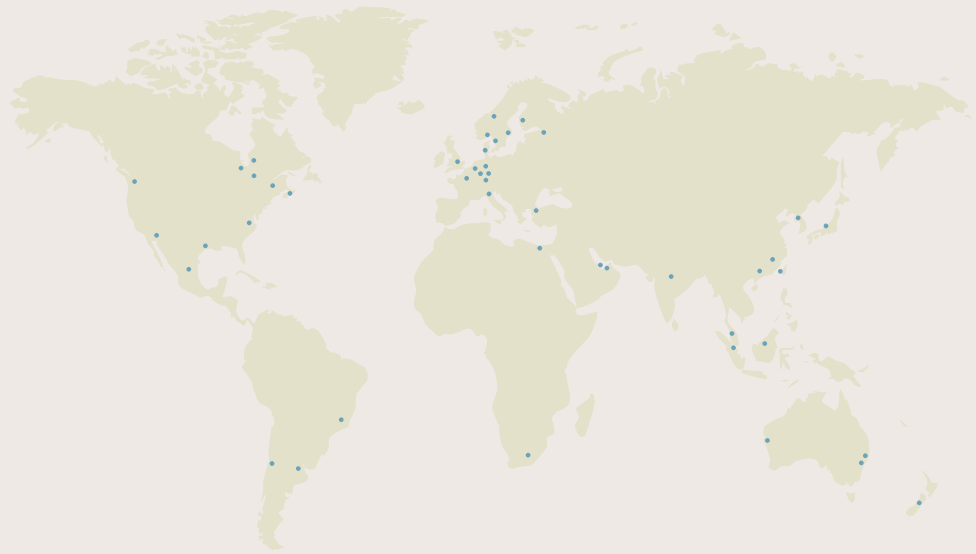

For more information please visit our website www.cavotec.com
or contact us directly at info@cavotec.com